

ULTRAPLUS M12-M36

The only undercut anchor to offer genuine 'cast-in' performance

Designed for exceptionally high loads in cracked and non-cracked concrete

FUNCTION

When the anchor is installed, the expansion segments are driven down to the previously created undercut. The spring automatically drives down the expansion cone which in turn expands the segments into the undercut with an audible 'click'.

This results in a 'positive undercut' connection without any expansion forces being transferred into the concrete.



European technical approval option1

BENEFITS

- High performance anchor - offering high loads in cracked and non-cracked concrete
- Designed for safety-critical applications
- Produced from high strength materials Gd10.9
- Unique spring activated anchor:
 - automatically compensates for tolerances in the fixture thickness
 - automatic engagement with the undercut in the concrete
- Modular design allowing for custom lengths and assemblies
- Proven performance for dynamic loads, shock loads and seismic conditions
- Detailed consultancy reports available for shock and ACI 355 compliance.

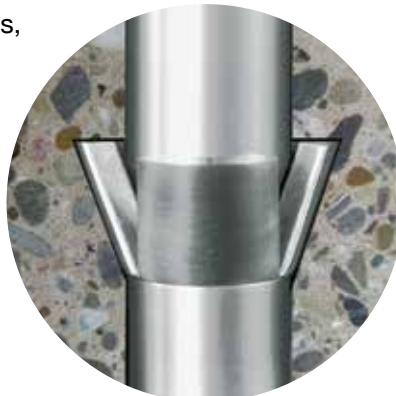

EJOT® High performance fastening with unrivalled global support

CONSTRUCTION

With hex nut, washer, threaded stud and plastic retaining ring



MATERIAL

High strength carbon steel, stainless steel

BASE MATERIAL

Cracked and non-cracked concrete

APPROVAL

- ETA-04/0098 – Option 1 – Approved for cracked and non-cracked concrete
- Independent verification according to ACI 355

LOAD RANGE

Tension: $N_{perm} = 19.0 - 320.2$ [kN] Shear: $V_{perm} = 45.2 - 371.4$ [kN]

PRODUCT RANGE

M12 – M36, carbon steel, zinc plated, HDG, sherardised, stainless steel

CHARACTERISTICS

- Positive undercut anchor with strong mechanical interlock
- Instant loading
- Completely removable
- Through-fix installation
- No expansion forces
- Small edge distances and anchor spacings

APPLICATIONS

- Nuclear power plants
- Industrial plants
- Water treatment plants
- Petrochemical installations
- Steel construction
- Cranes

BENEFITS

- Extremely high tensile and shear capacity
- Custom lengths and assemblies readily available
- Positive undercutting (comparable performance to a cast-in headed stud)

PRODUCT DESCRIPTION

With its unique undercutting technology **LIEBIG ULTRAPLUS** is designed to resist very high loads in applications where reliability and safety are absolutely essential. For example, anchoring safety relevant components in nuclear power plants, industrial plants, conveyor systems, cranes, and also for special civil engineering solutions.

After the hole is drilled, a separate undercut is created using the LIEBIG undercutting tool. When the anchor is inserted through the fixture, spring pressure opens the expanding segments. These lock into the undercut with a clearly audible click.

The result is a mechanical interlock without expansion stresses. By applying the specified torque, the fixture is fastened in position. The “positive undercut” allows perfect bearing of the segments and ensures reliable transmission of the load into the concrete.



European technical approval option1

ULTRAPLUS M12-M36

ULTRAPLUS Carbon Steel Zinc Plated and Stainless Steel A4

Threaded stud with hex nut and washer

*Available in high strength zinc plated, sherardised, HDG and stainless steel

Approval: ETA-04/0098 – Option 1 for cracked and non-cracked concrete



Custom lengths available on request.

Type	Order Code	Thread Size	Diameter x Depth of drilled hole	Max Fixture Thickness	Fixture Hole Diameter	Eff. Embedment Depth	Total Length	Weight (kg/100pcs)	Box Quantity
UP M12-23/140/20	UP1223140020	M12	23x190	20	24	140	220	48	10
UP M16-30/220/30	UP1630220030	M16	30x300	30	32	220	325	123	5
UP M20-36/250/50	UP2036250050	M20	36x330	50	38	250	380	173	5
UP M24-45/280/60*	UP2445280060	M24	45x410	60	46	280	460	408	2
UP M36-67/420/100*	UP3667420100	M36	67x570	100	68	420	700	1305	1

Also available in HDG, sherardised and stainless steel

*Not included in approval.

INSTALLATION ACCESSORIES

Undercutting tool for core drilling rigs with 1/2" drive



Diamond cutting blade



Compatible ULTRAPLUS	Order Code	KG/PC
M12	D23	2.6
M16	D30	3.1
M20	D36	4.1
M24	D45	5.1
M36	D67	8.1

Compatible ULTRAPLUS	Order Code	KG/PC
M12	DE23	0.5
M16	DE30	1.0
M20	DE36	1.2
M24	DE45	2.1
M36	DE67	3.3

Undercutting tool is available for either purchase or hire.

Installation data

Thread Size				M12	M16	M20	M24	M36
Drill hole diameter	d_0	[mm]		23	30	36	45	67
Drill hole depth	h_1	[mm]		190	300	330	410	570
Diameter of undercutting	d_1	[mm]		35	47	53.5	74	105
Undercutting	Δd_{out}	[mm]		6	8.5	8.75	14.5	19
Clearance hole in the fixture	Through-fix anchorage	d_f	[mm]	24	32	38	46	68
	Installation on threaded stud	d_f	[mm]	14	18	22	26	39
Width across flats	sw	[mm]		24	36	41	50	75
Installation torque	T_{inst}	[Nm]		120 (80 Stainless Steel)	250	300	790	2000

ULTRAPLUS INSTALLATION INSTRUCTIONS

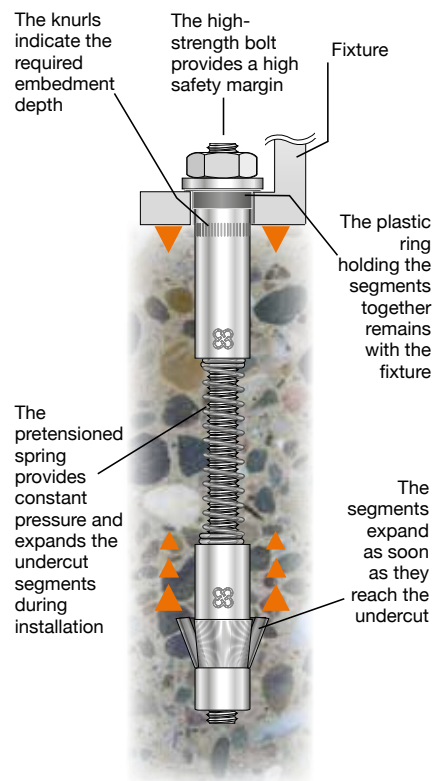
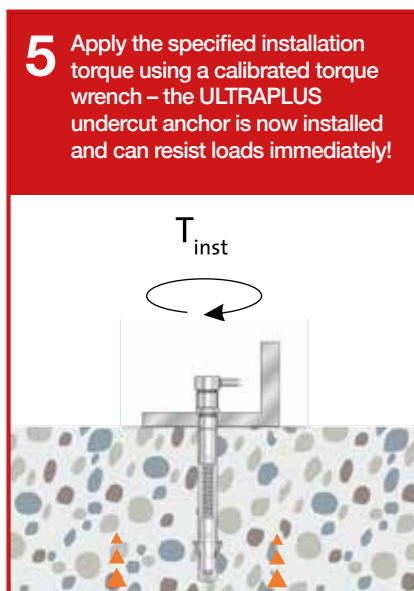
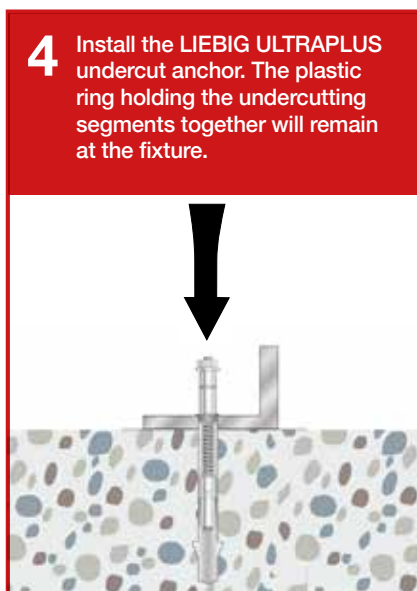
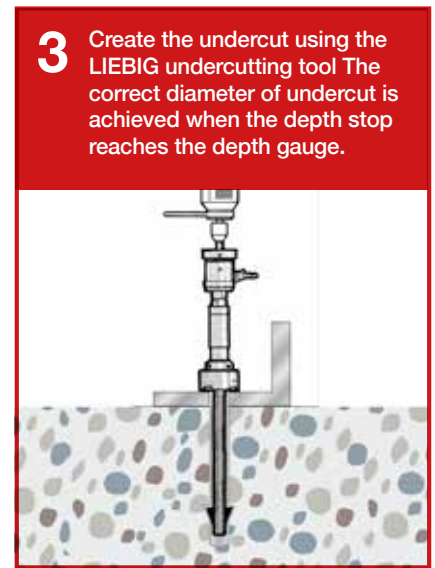
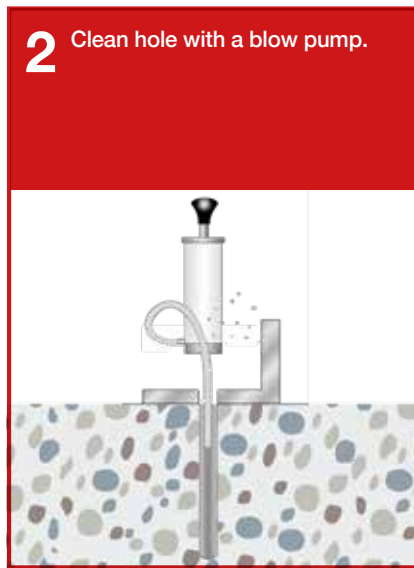

Installed anchor

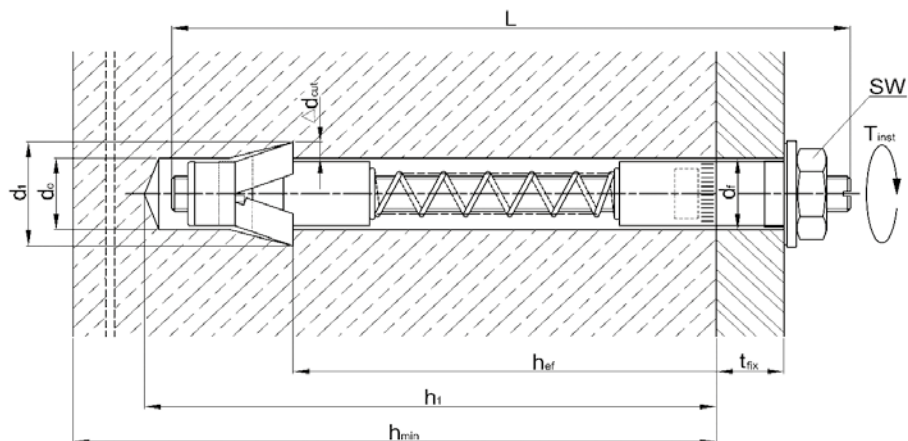

[Click here to watch the ULTRAPLUS Video](#) or scan the code below



Scan me

ULTRAPLUS Carbon Steel Zinc Plated

Permissible loads for single anchors with no influencing edge distances or spacings. Loads are calculated using partial safety factors from ETAG 001 and the characteristic anchor and installation data from this catalogue. Design calculations shall follow the requirements of ETA-04/0098. Material: Carbon steel zinc plated. (Stainless Steel A4). Please contact EJOT UK for load and performance data for the stainless steel version, or consult the technical manual.

Thread Size	M12	M16	M20	M24	M36
Effective embedment depth (mm)	140	220	250	280	420
Type UP	M12-23/140/...	M16-30/220/...	M20-36/250/...	M24-45/280/...	M36-67/420/...

Permissible tension loads¹⁾ - Carbon Steel Zinc Plated (Stainless Steel A4)

N_{perm}	Concrete	Type	[kN]	M12	M16	M20	M24	M36
	Cracked	C20/25	[kN]	19.0 (19.0)	35.7 (35.7)	45.2 (45.2)	80.3 (80.3)	147.6 (147.6)
		C30/37	[kN]	23.2 (23.2)	43.6 (43.6)	55.2 (55.2)	98.0 (98.0)	180.0 (180.0)
		C40/50	[kN]	26.9 (26.9)	50.4 (50.4)	63.8 (63.8)	113.3 (113.3)	208.1 (208.1)
		C50/60	[kN]	30.1 (29.9)	56.4 (56.3)	71.5 (71.5)	124.5 (124.5)	228.7 (228.7)
	Non-Cracked ³⁾	C20/25	[kN]	28.6 (28.6)	45.2 (45.2)	66.7 (66.7)	111.9 (111.9)	206.6 (206.6)
		C30/37	[kN]	34.9 (29.9)	55.2 (55.2)	81.3 (81.3)	136.5 (126.1)	252.0 (252.0)
		C40/50	[kN]	40.3 (29.9)	63.8 (56.3)	94.0 (87.5)	157.8 (126.1)	291.3 (291.8)
		C50/60	[kN]	43.4 (29.9)	71.5 (56.3)	105.3 (87.5)	173.5 (126.1)	320.2 (291.8)

Permissible shear loads²⁾ - Carbon Steel Zinc Plated (Stainless Steel A4)

V_{perm}	Concrete	Type	[kN]	M12	M16	M20	M24	M36
	Cracked	C20/25	[kN]	45.2 (48.3)	81.0 (85.9)	109.5 (123.5)	160.6 (160.6)	295.1 (295.1)
		C30/37	[kN]	45.2 (48.3)	81.0 (85.9)	109.5 (123.5)	164.6 (196.0)	360.0 (360.0)
		C40/50	[kN]	45.2 (48.3)	81.0 (85.9)	109.5 (123.5)	164.6 (196.0)	378.6 (416.1)
		C50/60	[kN]	45.2 (48.3)	81.0 (85.9)	109.5 (123.5)	164.6 (196.0)	378.6 (445.5)
	Non-Cracked ³⁾	C20/25	[kN]	45.2 (48.3)	81.0 (85.9)	109.5 (123.5)	164.6 (196.0)	378.6 (414.0)
		C30/37	[kN]	45.2 (48.3)	81.0 (85.9)	109.5 (123.5)	164.6 (196.0)	378.6 (445.8)
		C40/50	[kN]	45.2 (48.3)	81.0 (85.9)	109.5 (123.5)	164.6 (196.0)	378.6 (445.8)
		C50/60	[kN]	45.2 (48.3)	81.0 (85.9)	109.5 (123.5)	164.6 (196.0)	378.6 (445.8)

Permissible bending moments^{1) 5)} - Carbon Steel Zinc Plated (Stainless Steel A4)

M_{perm}	[Nm]	M12	M16	M20	M24	M36
		62.4 (56.4)	158.1 (142.9)	309.0 (278.7)	534.5 (481.1)	1881.7 (1693.5)

Spacings, edge distances and member thicknesses

Parameter	Symbol	[mm]	M12	M16	M20	M24	M36
Effective embedment depth	h_{ef}	[mm]	140	220	250	280	420
Characteristic spacing ⁴⁾	$s_{cr, N}$	[mm]	420	660	750	840	1260
Minimum spacing	s_{min}	[mm]	140	220	250	280	420
Characteristic edge distance ⁴⁾	$c_{cr, N}$	[mm]	210	330	375	420	630
Minimum edge distance	c_{min}	[mm]	140	220	250	280	420
Minimum member thickness	h_{min}	[mm]	240	360	400	500	700
			—	330 ⁶⁾	360 ⁶⁾	—	—

1) The permissible loads have been calculated using the partial safety factors for resistances stated in the ETA-approval and a partial safety factor for actions of $\gamma_f = 1.4$. The permissible loads are valid for unreinforced concrete and reinforced concrete with a rebar spacing $s \geq 15$ cm and reinforced concrete with a rebar spacing $s \geq 10$ cm if the rebar is 10 mm or smaller.

2) The permissible shear loads are based on a single anchor without influencing concrete edges. For shear loads applied close to an edge ($c \leq 10 h_a$ or 60 d) concrete edge failure must be checked per ETAG 001, Annex C, design method A.

3) Concrete is considered non-cracked when the tensile stress within the concrete is $\sigma_t + \sigma_n \leq 0$. In the absence of detailed verification $\sigma_n = 3$ N/mm² can be assumed (σ_t equals the tensile stress within the concrete as a result of external loads, forces on anchors included).

4) If spacings or edge distances become smaller than the characteristic values (i.e. $s \leq s_{cr, N}$ and/or $c \leq c_{cr, N}$) a calculation per ETAG 001, Annex C, design method A must be performed. For details, see ETA-04/0098.

5) The permissible bending moments are only valid for the threaded stud (e.g. in case of a distance mounting).

6) This h_{min} only applies when the remote face of the concrete is inspected to ensure there has been no break-through as a result of drilling. Otherwise $h_{min} = 360$ mm (M16) and $h_{min} = 400$ mm (M20).



EJOT UK Limited,
Hurricane Close,
Sherburn Enterprise Park,
Sherburn-in-Elmet,
Leeds LS25 6PB.
United Kingdom

Tel: +44 1977 68 70 40

Fax: +44 1977 68 70 41

Email: liebig@ejot.co.uk

www.ejot.co.uk



The ORIGINAL Anchoring Technology

www.liebig.co.uk